

Superior Competency for Edgebanding

SPRINT



PRODUCTIVITY AND PRECISION





Perfect Panel Processing is our Passion

Our engineers are among the world's best. Their visionary imagination and exceptional skill guarantee that our machines are the highest performance, most flexible and safest in the world today. Customers appreciate our capability to develop and produce excellent products quickly at equitable prices and high quality. Integrative, networked solutions are decisive for machining wood and panels worldwide.

This is why HOLZ-HER offers a range of products matched to one another and always develops a complete product series, from an entry-level machine right up through all performance ranges to the comprehensive top model. All service activities and product training courses are planned alongside new products. This ensures that, in addition to being offered a new machine, customers can also take advantage of a complete range of services. This focuses on practical solutions and greater customer benefit.

What You Can Expect from Us

- We want to understand our customers and partners as well as we possibly can and we want to optimize and increase their success by providing them with innovative products and services.
- Close contact with our dealers as well as with end customers, cabinet makers, interior architects and industrial workshops is one of HOLZ-HER's particular strengths.
- HOLZ-HER places a great deal of value on providing above-average performance in all areas, looking ahead to the future, achieving continuity and consistency in development and design and perfecting production, as well as providing in-depth sales and service advice.
- The ability to recognize and anticipate trends is a key skill for strong companies like HOLZ-HER. This requires the qualifications of each and every employee to be kept up to date. For this reason, HOLZ-HER places a great deal of emphasis on professional training for young employees. A choice selection of advanced occupational courses and personal training keep the learning process going.



The WEINIG Group: Machines and systems for solid wood and panel processing

Innovative state-of-the-art technology, comprehensive services and system solutions through to turnkey production lines: the WEINIG Group is your partner for profitable processing of solid wood and panels. WEINIG quality and profitability give small businesses and industrial operations a decisive edge in the global competition.



The Future of Edgebanding

Designed for highest requirements in terms of quality and flexibility. Various compact models are available for complete processing of state-of-the-art edging and panel material. Program selection allows the machine to be set up without even opening the hood, so that it is ready for production immediately. The HOLZ-HER SPRINT series set the highest, professional standards for edgebanding without compromises.

- Maximum precision and processing reliability for many years with torsionally stiff, welded machine columns.
- Ergonomic operation with rotating and pivoting control panel. Comprehensive program memory with complete storage of all operating data as well as service messages in clear text.
- Fully automatic control of processing machines at the touch of a button using NC servo-axes.
- All SPRINT models are equipped with our Glu Jet system as a standard feature for razor-thin glue joints, fully equal to any industrial laser edging.



Illustrations may contain optional features.

Simple handling – high productivity

■ Long, motor-driven run-in linear guide

For optimum feed of long workpieces. Joint thickness can be adjusted automatically at the touch of a button on the motor-driven run-in linear guide (optional) (Fig. 1).

■ 6-fold edge feeder

New with sensor for recognition of remaining length and automatic change-over to alternative edging channel. Including auxiliary shaft for feeding in cut-length edging (optional) (Fig. 2).

■ Radius scraper

For perfect smoothing of radiuses and chamfers on plastic edging. With four NC servo-axes for exact adjustment of tool depth when using high gloss panels with protective foil (optional) (Fig. 3).

■ Nesting package

For concealed hinge holes or trapezoidal work (optional) (Fig. 4).

■ Transport chain lubrication

Intelligent automatic transport chain lubrication. Sensor-controlled unit, for metering lubrication to match load (optional).



W^{4.0} digital

Future-proofing for your business by digitization of the production processes.

ECOMODE

Intelligent energy management for HOLZ-HER edgebanders.

SYNCHRO

For short intervals between workpieces and optimized edge protrusions.

Edge Control Touch

The HOLZ-HER Edge Control Touch provides extremely high performance and is exemplary for its simple operation. Ergonomic, simple and uniform tablet design.

Display

- 18.5"-Touch screen with 16:9 format.
- Brilliant graphic display of machining process.
- Simple operation – rotating and swiveling control panel at eye height.

Operation

- Electronically controlled set-up processes with 100% repetition accuracy.
- Clear and complete acquisition of all operating data: Total running meters, total parts, total hours with reset.
- Custom user management with password protection and single authorization.

Equipment/Service

- Network connectivity.
- Online maintenance, high speed data interchange with HOLZ-HER service department.
- Barcode interface for automatic program call-up.
- External USB port for data backup and system updates.
- Connection to HOLZ-HER process data acquisition system for direct read-out of operating data (optional).

Pictograms

- The Edge Control offers self-explanatory, graphic pictograms for simple user guidance.

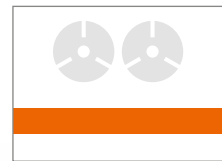

Edge Control Touch –
high standards guarantee your
investment for the future.



iTronic

The optimized, automatic control for the extensive pressure adjustments with plausibility checks allows HOLZ-HER to realize automatic glue quantity control matched to the specific requirements. Moreover, an adaptive trimming blade automatically adapts the pressure to the edge thickness. And, an adaptive pressure unit optimally adjusts the pressures of the individual pressure rollers to the specific application for perfect results every time. This reduces adjustment errors and reject quotas to a minimum.

As a special feature, the iTronic package includes a fully automatic cleaning feature for PUR glue as well as a remaining glue quantity indicator on the control to show you exactly how many more running meters you can produce at any time.

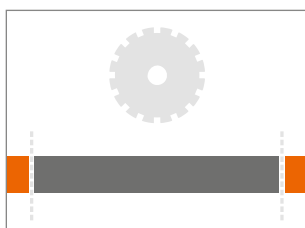

Adaptive trimming blade

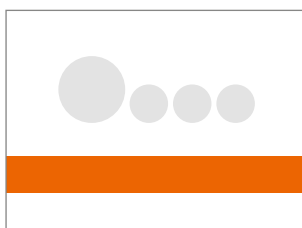

Adaptive pressure unit

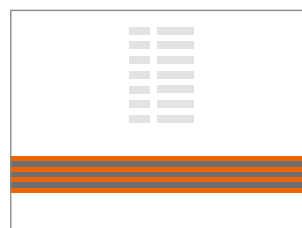

Automatic glue quantity control

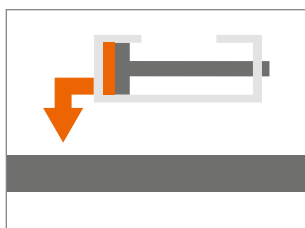

Automatic cleaning routine

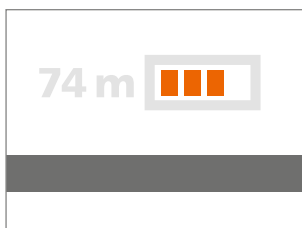

Remaining glue quantity indicator

Glu Jet – Zero Joint with Thin Film Technology

The clear advantages of our hybrid technology in combination with the new HOLZ-HER thin film technique make this gluing system the all-rounder for craftsmen and industrial users. Visual zero joints with PUR glue – allowing use in wet areas – are natural for HOLZ-HER customers.

Ultra-thin glue joints, easily equivalent to industrial laser edges, are easy to achieve with the HOLZ-HER Glu Jet system, which also offers unrivaled flexibility.

From state-of-the-art, high gloss edging right up to thick edging cross sections in the solid wood range, HOLZ-HER remains unequaled in terms of appearance, regardless of the material. HOLZ-HER sets tomorrow's trends today.

Glue change and cleaning require only 3 minutes each



Heat-up time
3 minutes



Glue change*
3 minutes

* to PUR glue, to EVA glue and color change



Cleaning
3 minutes

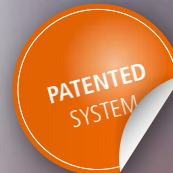



PUR glue is the standard for professional cabinet makers

Industrial technology for every shop – with the Glu Jet System you can process PUR glue on a standard basis; just as simply as EVA glue. Strong arguments for you and your customers:

- No additional glue basin.
- No expensive nitrogen tanks.
- High strength joint for extremely long service life.
- Resistant to heat and water, providing quality advantages in all areas of cabinetmaking.

**Waterproof PUR glue – ideal for
kitchen and bath furniture**



Units for 100 Percent Repetition Accuracy!

All units must satisfy maximum requirements right down to the last detail to obtain the same, precision results repeatedly at high processing rates. The shaping cutter unit is an example of what is important.

Because 100 percent repetition accuracy is highly significant for professional edgebanding.

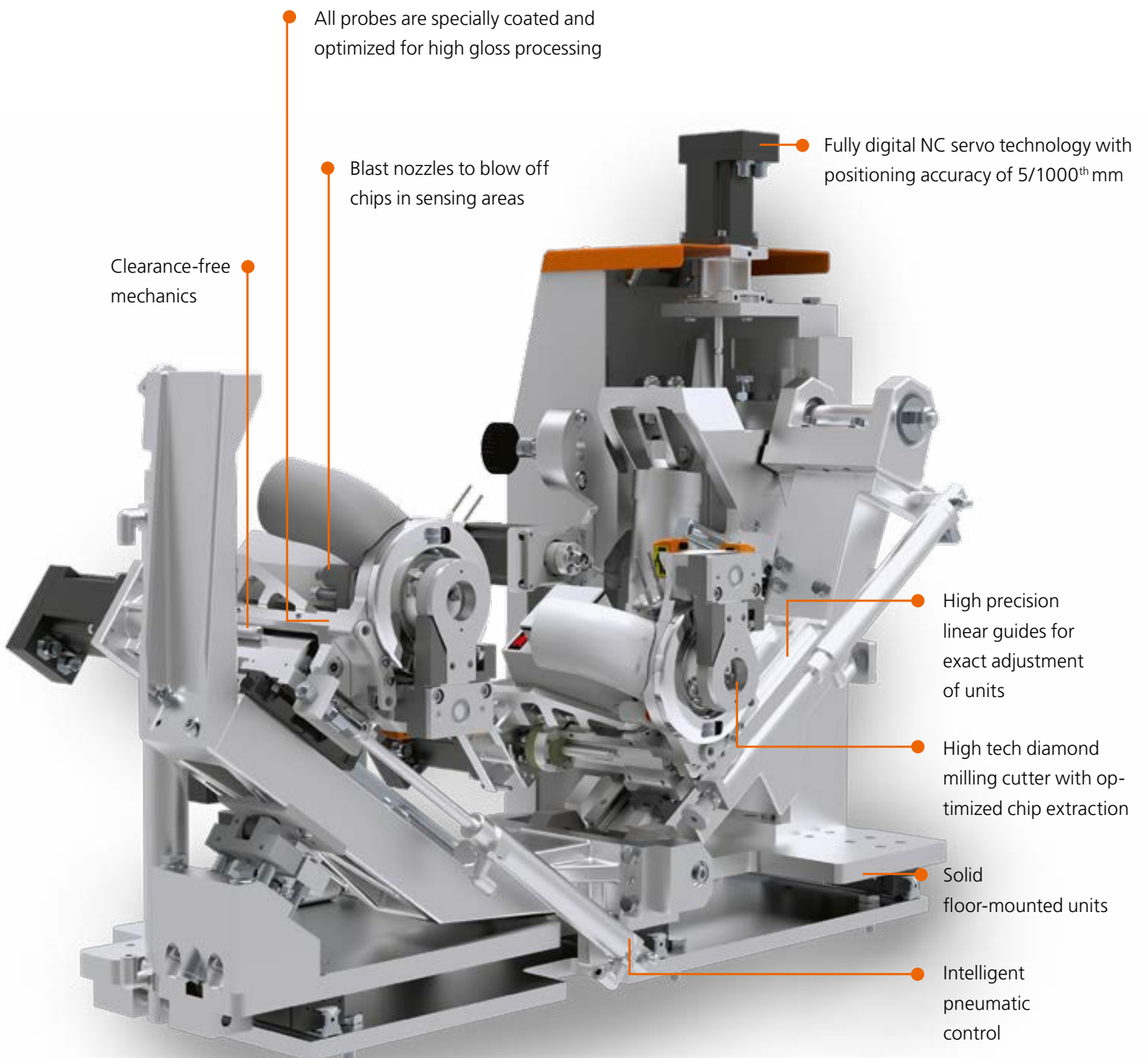



Pre-milling dia. 70 mm

Cut edgings often have small tears in the top layer. The jointing cutter unit ensures perfect glued surfaces and prepares the panels for the gluing process. Equipped with patented AirStream technology and diamond-tipped tools.

Including height adjustment for optimum utilization of cutters.



Edge feeder SYNCHRO

The new edging magazine with SYNCHRO drive. The new magazine with its synchronous adaptation to the feed rate guarantees short intervals between workpieces and simultaneously optimizes edging protrusions.

Small feed angle thanks to nozzle design – easy feeding of solid wood edging up to 15 mm.

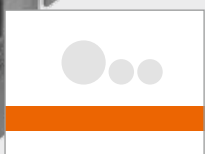

Motor-driven pressure unit

Synchronously driven pressure unit with automatic adaptation to feed rate thanks to NC servo-axes for motor-driven adjustment to correct edge thickness (optional).

Straight and tapered pressure rollers for perfectly glued joints.

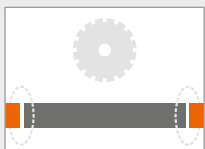
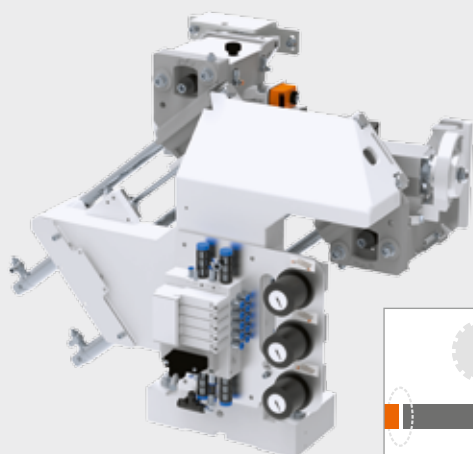

Pneumatic end trimming unit

For straight or chamfered end trimming on thin edging; a standard feature allows this unit to be pivoted to 10 degrees pneumatically. High quality version with stable cast iron pillars.

Sawing motors each with two guides for precisely trimming off protruding edging.

Convincing Cutting Results Up to Edge Thicknesses of 15 mm

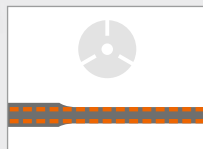

Flush cutting unit (up to 15 mm)

High performance cutting unit for edge thicknesses up to 15 mm. Two NC servo-axes for cutting with and without edge protrusion (optional).

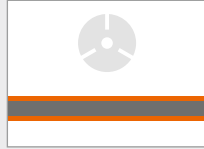

Pneumatic cutter unit

Multifunction cutter unit for flush cut on edging with thickness up to 8 mm, radiuses up to 3 mm, pivots 0–15 degrees. Including diamond tools.

Further equipment:

- Integrated chip collection in tool
- ProLock system
- Motorized version (optional)

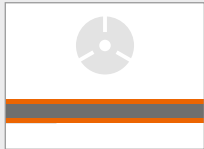

Cutter unit 6 NC servo-axes

For flush, radius and bezel cuts including permanently installed diamond tool with patented Air Stream system. Also available with optional fully automatic control with six NC servo-axes.

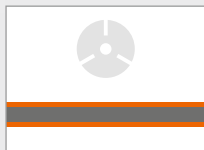

Multi-function cutting unit 6 NC servo-axes

Heavy-duty floor-mounted unit with shock-absorbing mounting and large tracing rollers for perfect results even at high feed rates. 100 percent repetition accuracy at the touch of a button based on zero-clearance mechanisms and 6 high precision NC servo-axes. Horizontal sensing with angular sensing rollers developed especially for processing modern, high gloss edging.

Optional: With multiple stage cutter.

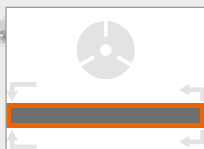
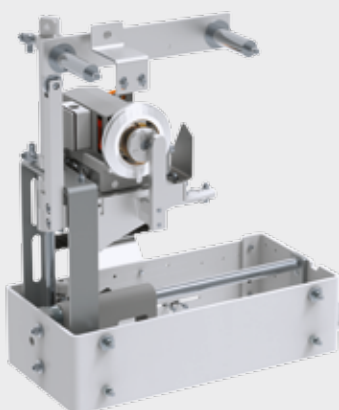

Corner copying unit

Unit for copying vertical, end edges, various edge profiles possible – including postformed profiles. Integrated chip removal. With diamond tipped tools for long tool service life.

Maximum workpiece thickness 60 mm.

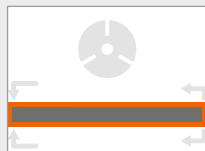

Form trimming unit 4 NC servo-axes

Form trimming unit for corner copying. Machining with two cutter motors for a wide variety of postforming profiles. Including four NC servo-axes and two diamond tipped cutters with CM technology and ProLock quick-change chuck.

Maximum workpiece thickness 60 mm.

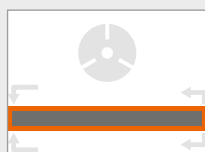
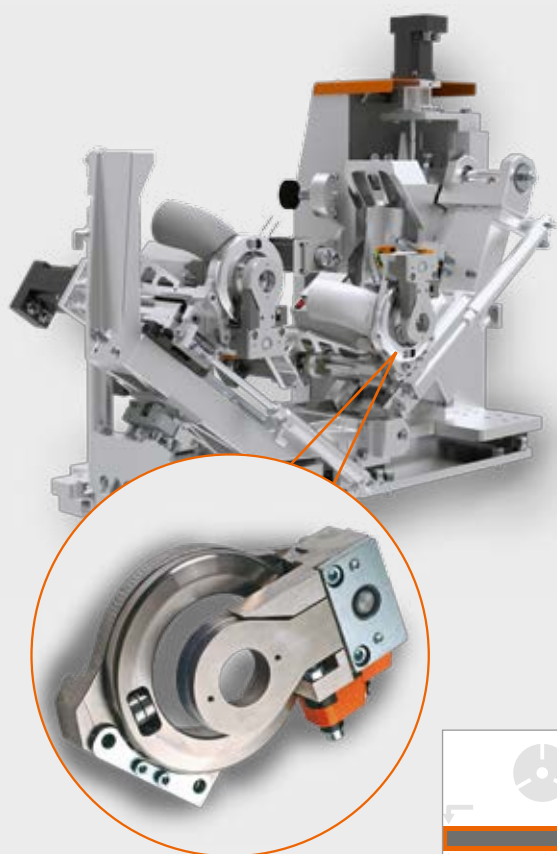

Form trimming unit 4 highspeed NC servo-axes

Unit adjustment on linear guides. With standard blow nozzles in front of sensing rollers to blow away chips in front of sensing areas. Including shelf program for optimum processing of shelves with rounded edges. Including intelligent pneumatic system to automatically adapt machining pressure settings to match feed rate and panel thickness.

■ Pendulum sensor

Automatic pendulum sensor copies rear without material protrusion and leaves the optimum edge protrusion for the longitudinal edge for subsequent machining.

Grooving unit (ccw)

With two NC servo-axis for groove depth adjustment as well as groove positioning via control panel as a standard feature. Pivots 0 – 90 degrees.

Including:

- Grid holes at increments of 11.25 degrees
- Plunge control
- 4.2 mm groove cutter (further groove widths on request)

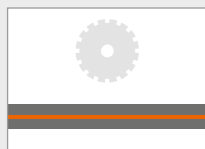
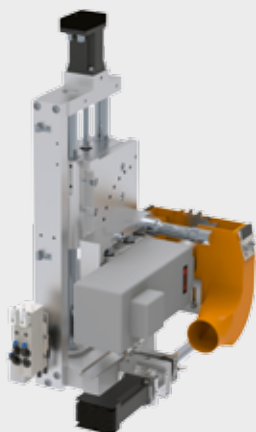

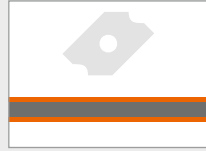
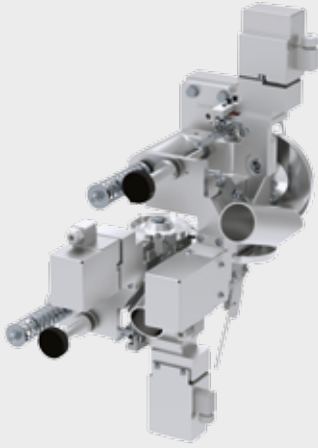

Scraper unit

For perfect smoothing of radiuses and chamfers on plastic edging.

Also available as high gloss package with four NC servo-axes (optional).

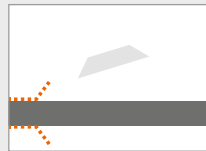
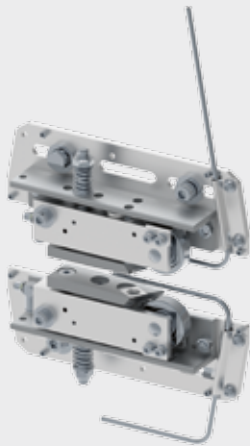

Glue scraper

Clean post-processing of surfaces. Application controlled with two reversible blades, manual post-processing not required. Standard setup.

Also with pre and post tracing (optional).

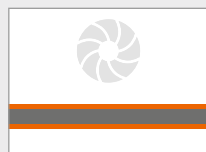

Buffing unit







Polishing for maximum gloss; for complete finishing. Standard setup.



Spraying devices

Spraying units for parting agents and cleaning agents for feed and discharge area. Anti-static, coolant and lubricant – electronically controlled by special nozzles – for perfect edge finishing. The various fluid reservoirs are all integrated cleanly into the machine frame.

Overview of SPRINT Series

Machine	SPRINT 1327 classic	SPRINT 1327 massiv	SPRINT 1329 massiv	SPRINT 1329 grooving	SPRINT 1329 premium	SPRINT 1329 performance
Control	PPC 315 with Touchscreen	PPC 315 with Touchscreen	PPC 315 with Touchscreen	PPC 315 with Touchscreen	PPC 315 with Touchscreen	PPC 315 with Touchscreen
Bridge	Motor-driven	Motor-driven	Motor-driven	Motor-driven	Motor-driven	Motor-driven
Magazine	SYNCHR 	SYNCHR 	SYNCHR 	SYNCHR 	SYNCHR 	SYNCHR 
	6-fold magazine	6-fold magazine	6-fold magazine	6-fold magazine	6-fold magazine	6-fold magazine
Edging magazine	40 mm	150 mm	150 mm	40 mm	40 mm	150 mm
	150 mm			150 mm	150 mm	
Pre-milling	60 mm	60 mm	60 mm	60 mm	60 mm	60 mm
Glue application	Glu Jet (thin film technology)	Glu Jet (thin film technology)	Glu Jet (thin film technology)	Glu Jet (thin film technology)	Glu Jet (thin film technology)	Glu Jet (thin film technology)
	Glu Jet automatic	Glu Jet automatic	Glu Jet automatic	Glu Jet automatic	Glu Jet automatic	Glu Jet automatic
	Motor-controlled nozzle	Motor-controlled nozzle	Motor-controlled nozzle	Motor-controlled nozzle	Motor-controlled nozzle	Motor-controlled nozzle
Pressure unit	3 pneumatic rollers	3 pneumatic rollers	3 pneumatic rollers	3 pneumatic rollers	3 rollers Motor-driven	3 rollers Motor-driven
	Motor-driven	Motor-driven	Motor-driven	Motor-driven		
End trimming	Two-motor	Two-motor	Two-motor	Two-motor	Two-motor	Two-motor
Cutter 1	Multi-function 8 mm	Flush 15 mm	Flush 15 mm	Multi-function 8 mm	Multi-function 8 mm	Multi-function 8 mm
	+ MOT versions	+ MOT versions	+ MOT versions	+ MOT versions	+ MOT versions	Multistage tool
Cutter 2	x	Multi-function 8 mm	Multi-function 8 mm	x	x	x
		+ MOT versions	+ MOT versions			
Corner copying	60 mm, single-motor	x	60 mm, single-motor	60 mm, single-motor	60 mm two motor MOT 4	60 mm two motor MOT 4 highspeed
Scraper unit	Pneumatic	Pneumatic	Pneumatic	Pneumatic	Pneumatic	MOT 4
	+ MOT versions	+ MOT versions	+ MOT versions	+ MOT versions	+ MOT versions	
Glue scraper	Application controlled	Application controlled	Application controlled	Application controlled	Application controlled	Application controlled
	With pre and post tracing	With pre and post tracing	With pre and post tracing	With pre and post tracing	With pre and post tracing	With pre and post tracing
Buffing	Pivoting 5° (standard)	Pivoting 5° (standard)	Pivoting 5° (standard)	Pivoting 5° (standard)	Pivoting 5° (standard)	Pivoting 5° (standard)
Grooving	x	x	x	MOT 2	x	x

 Standard

 Optional

 Not possible

	SPRINT 1327 classic	SPRINT 1327 massiv	SPRINT 1329 massiv	SPRINT 1329 grooving	SPRINT 1329 premium	SPRINT 1329 performance
Machine dimensions						
Overall length A (mm)	5190	5190	5590	5590	5590	5590
Total length with air cushion table and extended discharge B (mm)	6990	6990	7390	7390	7390	7390
Width x height (mm)	1828 x 2030	1828 x 2030	1828 x 2030	1828 x 2030	1828 x 2030	1828 x 2030
Weight (kg)	1750	1750	2000	2000	2000	2000
Feed rate						
Feed rate (m/min)	10 – 18	10 – 18	10 – 18	10 – 18	10 – 18	10 – 18
Working dimensions						
Minimum workpiece length (mm)	160	160	160	160	160	160
Minimum workpiece width (mm)	60	60	60	60	60	60
Workpiece thickness (mm)	8 – 60	8 – 60	8 – 60	8 – 60	8 – 60	8 – 60
Edge width (mm)	0,4 – 8(15*)	0,4 – 15	0,4 – 15	0,4 – 8(15*)	0,4 – 8(15*)	0,4 – 8(15*)

* with tool change

TECHNICAL DATA

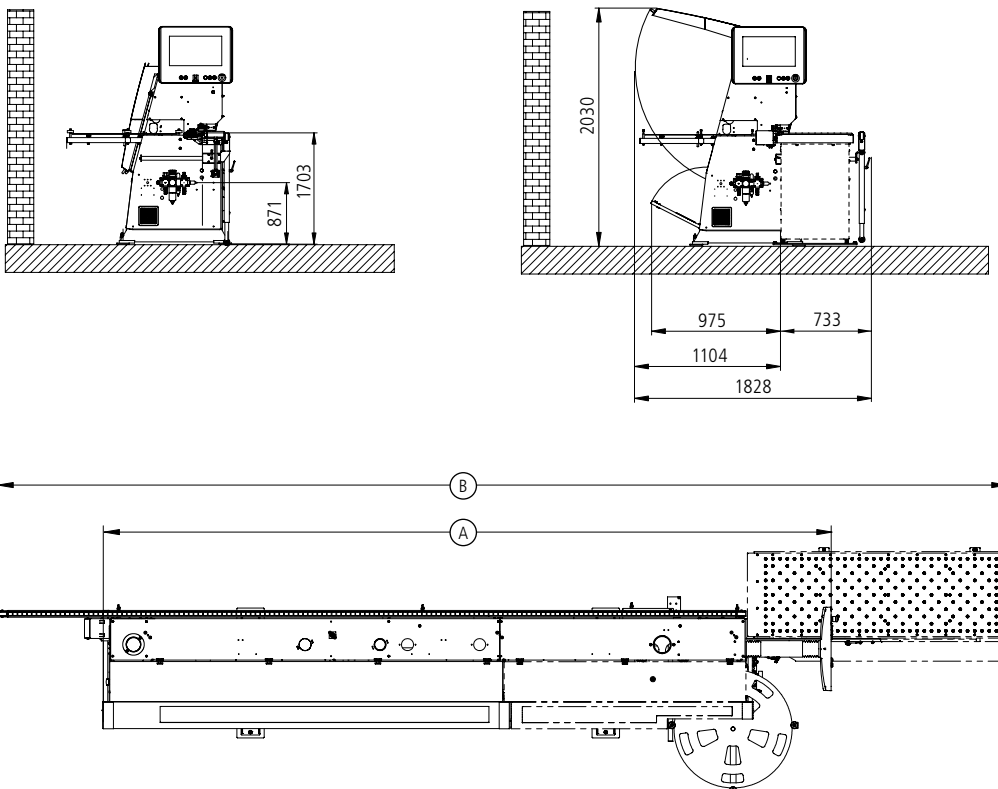

Intelligent Return System for Greater Efficiency

The intelligent HOLZ-HER return system is the perfect supplement to the SPRINT series. This high performance module is distinguished by its high flexibility in use and amortizes itself quickly for all lot sizes.

- A 90 /180 degree turning device is included as a standard feature.
- The return system transports the parts securely, gently and reliably back to the infeed area on the SPRINT machine or stacks it.
- Feed rates from 0 to 18 m/min., automatic adaptation to SPRINT feed system.

Time losses and jams resulting from manual removal of the work are a thing of the past; economical one-man operation of the SPRINT machine becomes the rule.



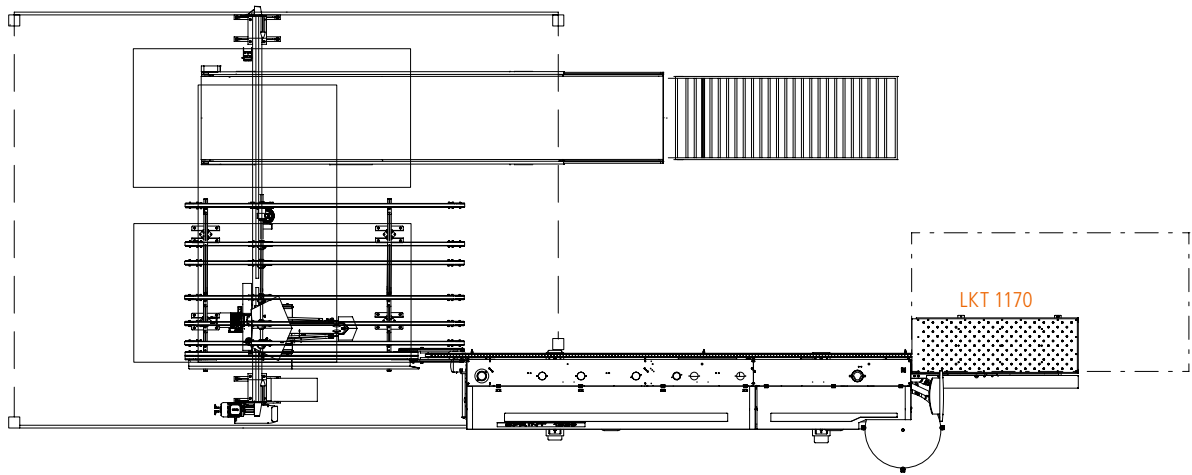

Air Cushion Table for Improved Handling

Feed using the optional air cushion table is particularly simple and gentle on material. The air cushion ensures simple, gentle handling of the work. Long parts can be positioned precisely and guided into the SPRINT machine.

Product brochures and many
videos are available at
www.holzher.com



The technical data specified is intended for reference only. HOLZ-HER woodworking machines are subject to constant development and are therefore subject to modification without prior notice. The illustrations are therefore not binding. Some of the machines shown also contain special equipment not included as a standard feature. For clarity, some of the machines are shown without protective hood.

Picture credits: istock.com – © lisegagne | Shutterstock.com – © bioraven |
Fotolia.com – © Alexander Rochau; Westend61

UK – HOLZ-HER 3691 45 – Printed in Germany/Imprimé en Allemagne
Printed on: 15.06.2018 – First edition: 26.04.2013

Your authorized HOLZ-HER dealer



HOLZ-HER GmbH
Plochinger Straße 65
72622 Nürtingen
Germany
T +49 (0) 70 22 702-0
kontakt@holzher.com
www.holzher.com

HOLZHER

A member of the WEINIG Group